

THIS MANUAL IS AN ONLINE BACKUP TO YOUR
ORIGINAL HARDCOPY VERSION.

RX7CITY.COM ASSUMES NO RESPONSIBILITY IN HOW YOU USE
THIS MANUAL. THIS MANUAL IS FOR EXPERIENCED MECHANICS
AND IS TO BE USED AT YOUR OWN RISK!



PRE-DELIVERY INSPECTION AND SCHEDULED MAINTENANCE SERVICES

PRE-DELIVERY INSPECTION TABLE A - 2
SCHEDULED MAINTENANCE SERVICES A - 3
 SCHEDULE 1
 (NORMAL DRIVING CONDITION) A - 3
 SCHEDULE 2
 (UNIQUE DRIVING CONDITION) A - 4

07U0AX-007

A

PRE-DELIVERY INSPECTION TABLE

PRE-DELIVERY INSPECTION TABLE

The following items may be done at any time prior to delivery to your customer.

EXTERIOR

INSPECT and **ADJUST**, if necessary, the following items to the specifications:

- Glass, exterior bright metal, and paint for damage
- Wheel lug nuts and locks
89–117 N·m {9.0–12.0 kgf·m, 66–86 ft·lbf}
- All weather strips for damage and detachment
- Operation of hood release and lock
- Operation of fuel lid and rear hatch opener
- Door operation and alignment
- Headlight aim

INSTALL the following parts

- Wheel caps (if equipped)
- Outside rearview mirror (s)
- Front air deflector (if equipped)

REMOVE

- Tie-down hooks

UNDER HOOD—ENGINE OFF

INSPECT and **ADJUST**, if necessary, the following items to the specifications:

- Fuel, coolant, and hydraulic lines, fittings, connections, and components for leaks
- Engine oil level
- Power steering fluid level
- Brake and clutch master cylinder fluid levels
- Windshield washer reservoir fluid level
- Radiator coolant level and specific gravity
- Tightness of battery terminals

INTERIOR

INSTALL the following parts:

- Rubber stopper for inside rearview mirror
- CHECK** the operations of the following items:
 - Seat controls (sliding and reclining) and headrest
 - Door locks
 - Seat belts and warning system
 - Ignition switch and steering lock
 - Air bag system using indicator light (if equipped)
 - Shift-lock system and inhibitor switch (A/T only)
 - Starter interlock switch (clutch pedal, M/T only)
 - All lights including warning and indicator lights and retractable headlight mechanism
 - IC audible warning system
 - Horn, wipers, and washers (front and rear, if equipped)
 - Radio and antenna (if equipped)
 - Cigarette lighter and clock
 - Remote control outside rearview mirror (if equipped)
 - Power windows (if equipped)
 - Heater, defroster, and air conditioner at all mode selections (if equipped)
 - Sunroof (if equipped)

- Theft-deterrent system (if equipped)

CHECK the following items:

- Spare fuse
- Upholstery and interior finishes

CHECK and **ADJUST**, if necessary, the following items:

- Pedal height and free play of brake and clutch pedal

	Pedal height mm (in)	Pedal free play mm (in)
Clutch pedal	183–193 {7.20–7.60} (With carpet)	0.6–3.0 {0.02–0.12}
Brake pedal	184–189 {7.24–7.44} (With carpet)	3.0–8.0 {0.12–0.31}

- Parking brake

7–10 notches / 200 N {20 kgf, 44 lbf}

UNDER HOOD—ENGINE RUNNING AT OPERATING TEMPERATURE

CHECK the following items:

- Bypass air control system
- Automatic transmission fluid level

ON HOIST

CHECK the following items:

- Manual transmission oil level
- Rear axle oil level
- Underside fuel, coolant, and hydraulic lines, fittings, connections, and components for leaks
- Tires for cuts and bruises
- Steering linkage, suspension, exhaust system, and all underside hardware for looseness or damage

ROAD TEST

CHECK the following items:

- Brake operation
- Clutch operation
- Steering control
- Operation of meters and gauges
- Squeaks, rattles, or unusual noises
- Emergency locking retractors
- Cruise control system (if equipped)

AFTER ROAD TEST

- CHECK** for necessary owner information materials, tools, and spare tire in vehicle
- REMOVE** identification color tape on directional tires

Following items must be done just before the delivery to your customer.

- Load test battery and charge if necessary
- Adjust tire pressure to the specification
(Refer to Section Q)
- Clean outside of vehicle

- Install fuses for accessories
- Remove seat and floor mat protective covers
- Vacuum inside of vehicle

SCHEDULED MAINTENANCE SERVICES

MAINTENANCE TABLE (USA)

Follow Schedule 1 (Normal Driving Conditions) if the vehicle is operated mainly where none of the following conditions apply. Follow Schedule 2 (Unique Driving Conditions) if any of the conditions below apply.

- Repeated short-distance driving
- Driving in dusty conditions.
- Driving with extended use of brakes.
- Driving in areas where road salt or other corrosive materials are used.
- Driving on rough and/or muddy roads.
- Extended periods of idling and/or low-speed operation.
- Driving for prolonged periods in cold temperatures and/or extremely humid climates.

Schedule 1 (Normal Driving Conditions)

Maintenance Interval	Number Of Months Or Miles (Kilometer), Whichever Comes First									
	X 1000	Months	7.5	15	22.5	30	37.5	45	52.5	60
		Miles	7.5	15	22.5	30	37.5	45	52.5	60
Operation	Km	12	24	36	48	60	72	84	96	

Engine

Engine Oil	Replace every 5,000 miles (8,000 km) or 5 months
Oil Filter	Replace every 5,000 miles (8,000 km) or 5 months
Drive Belts	I

Air cleaner

Air Cleaner Element	R	R
---------------------	---	---

Ignition system

Spark Plugs	R	R
-------------	---	---

Fuel system

Idle Speed	I*2	I*2	I*2	I
Fuel Filter				R
Fuel Lines		I*1		I

Cooling system

Cooling System	I	I	I	I
Engine Coolant		R		R

Chassis & body

Brake Lines, Hoses & Connections				I	I	I	I
Disc Brakes				I			I
Steering Operations & Linkages				I			I
Front & Rear Suspension Ball Joints				I			I
Rear Suspension Uni Ball & Sliding Rubber Bushing				I			I
Manual Transmission Oil							R
Rear Axle Oil							R
Drive Shaft Dust Boots				I			I
Bolts & Nuts on Chassis & Body				T			T
Exhaust System Heat Shield				I			I
All Looks & Hinges	L	L	L	L	L	L	L

Air conditioner system (If equipped)

Refrigerant	Inspect the refrigerant amount annually
Compressor	Inspect the operation annually

Electrical system

Engine Oil Level Warning System	I	I	I	I
Engine Coolant Level Warning System				I

Chart symbols:

- I: Inspect and, if necessary, correct, clean, or replace
- R: Replace or change
- T: Tighten
- L: Lubricate

Remarks:

After 60 months or 60,000 miles (96,000 km), continue to follow the prescribed maintenance items and intervals periodically. As for * marked items in this maintenance chart, please pay attention to the following points.

*1 This maintenance operation is recommended by Mazda. However, it is not necessary for emission warranty coverage or manufacturer recall liability.
 *2 This maintenance operation is required for Canada and all states except California. However, we recommend that it also be performed on California vehicles as well.

A

SCHEDULED MAINTENANCE SERVICES

Schedule 2 (Unique Driving Conditions)

Maintenance Operation	Maintenance Interval	Number Of Months Or Miles (Kilometer), Whichever Comes First												
		Months	5	10	15	20	25	30	35	40	45	50	55	60
		X1000 Miles	5	10	15	20	25	30	35	40	45	50	55	60
	X1000 Km	8	16	24	32	40	48	56	64	72	80	88	96	

Engine

Engine Oil	Replace every 3,000 miles (5,000 km) or 3 months
Oil Filter	Replace every 3,000 miles (5,000 km) or 3 months
Drive Belts	

Air cleaner

Air Cleaner Element		R											R
---------------------	--	---	--	--	--	--	--	--	--	--	--	--	---

Ignition system

Spark Plugs						R								R
-------------	--	--	--	--	--	---	--	--	--	--	--	--	--	---

Cooling system

Cooling System			I											
Engine Coolant						R								F

Fuel system

Fuel Filter														F
Fuel Lines							I*1							
Idle Speed			I*2				I*2			I*2				

Chassis & body

Brake Lines, Hoses & Connections									I					I
Brake Fluid									R					F
Disc Brakes									I					I
Steering Operations & Linkages									I					I
Front & Rear Suspension Ball Joints									I					I
Rear Suspension Uni Ball & Sliding Rubber Bushing									I					I
Manual Transmission Oil									R					R
Rear Axle Oil									R					R
Drive Shaft Dust Boots									I					I
Bolts & Nuts on Chassis & Body				T					T			T		T
Exhaust System Heat Shield									I					I
All Locks & Hinges	L	L	L	L	L	L	L	L	L	L	L	L	L	L

Air conditioner system (If equipped)

Refrigerant	Inspect the refrigerant amount annually
Compressor	Inspect the operation annually

Electrical system

Engine Oil Level Warning System														
Engine Coolant Level Warning System														

Chart symbols:

- I: Inspect and, if necessary, correct, clean, or replace
- R: Replace or change
- T: Tighten
- L: Lubricate

Remarks:

After 60 months or 60,000 miles (96,000 km), continue to follow the prescribed maintenance items and intervals periodically.

As for * marked items in this maintenance chart, please pay attention to the following points.

- *1 This maintenance operation is recommended by Mazda. However, it is not necessary for emission warranty coverage or manufacturer recall liability.
- *2 This maintenance operation is required for Canada and all states except California. However, we recommend that it also be performed on California vehicles as well.

SCHEDULED MAINTENANCE SERVICES

A

MAINTENANCE TABLE (CANADA)

Maintenance Interval Maintenance Operation	Number Of Months Or Miles (Kilometer), Whichever Comes First												
	Months	5	10	15	20	25	30	35	40	45	50	55	60
	X1000 Km (X1000 Miles)	8	16	24	32	40	48	56	64	72	80	88	96

Engine

Engine Oil	Replace every 5,000 kilometers or every 3 months												
Oil Filter	Replace every 5,000 kilometers or every 3 months												
Tension of All Drive Belts	Inspect every 5,000 kilometers or every 3 months												

Air cleaner

Air Cleaner Element							R							F
---------------------	--	--	--	--	--	--	---	--	--	--	--	--	--	---

Ignition system

Spark Plugs							R							F
-------------	--	--	--	--	--	--	---	--	--	--	--	--	--	---

Cooling system

Engine Coolant Level & Strength	Inspect every 5,000 kilometers or every 3 months													
Cooling System for Leaks							I							I
Engine Coolant							R							F

Fuel system

Idle Speed							I							I
Fuel Lines & Hoses							I*							I
Fuel Filter							R							F
Emission Hoses & Tubes														I

Chassis & body

Manual Transmission Oil Level							I							I
Automatic Transmission Fluid Level	Inspect every 5,000 kilometers or every 3 months													
Transmission Oil M/T & A/T							R							R
Oil Level in Final Drive Case	Inspect every 5,000 kilometers or every 3 months													
Differential Oil							R							R
Driveshaft Dust Boots							I							I
Brake Lines & Hoses							I							I
Brake & Clutch Fluid Level	Inspect every 5,000 kilometers or every 3 months													
Brake Fluid							R							R
Disc Brakes (Front & Rear)							I							I
Tire Inflation Pressure & Tire Wear	Inspect every 5,000 kilometers or every 3 months													
Rotate Tires	Rotate every 24,000 kilometers or every 15 months													
Power Steering Fluid Level	Inspect every 5,000 kilometers or every 3 months													
Steering Operation & Linkage (Includes Four Wheel Alignment)							I							I
Suspension Components Front & Rear							I							I
Rear Suspension Uniball & Sliding Rubber Bushing							I							I
All Chassis & Body Nuts & Bolts				T			T				T			T
Exhaust System Heat Shield							I							I
All Locks & Hinges	Lubricate every 5,000 kilometers or every 3 months													
Washer Fluid Level	Inspect every 5,000 kilometers or every 3 months													
Function of All Lights	Inspect every 5,000 kilometers or every 3 months													
Engine Oil Level Warning System							I							I
Engine Coolant Level Warning System							I							I

Air conditioner system (If equipped)

Refrigerant	Inspect the refrigerant amount annually												
Compressor	Inspect the operation annually												

A

SCHEDULED MAINTENANCE SERVICES

Note:

I : Inspect and if necessary, correct, clean, or replace.
(Inspect and if necessary, replace air cleaner element only)

R: Replace or change

T: Tighten

L: Lubricate

After 60 months or 96,000 km (60,000 miles), continue to follow the described maintenance items at the intervals periodically.

Please pay attention to the following point.

This maintenance is recommended by Mazda; however it is not necessary for emission warranty coverage or manufacturer recall liability.

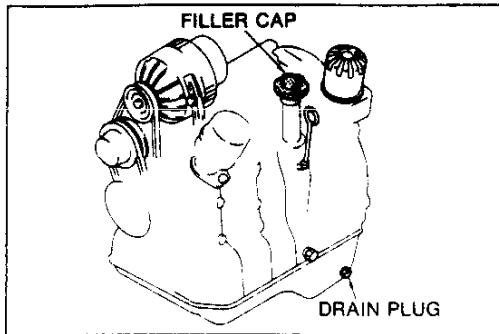

77U00X-015

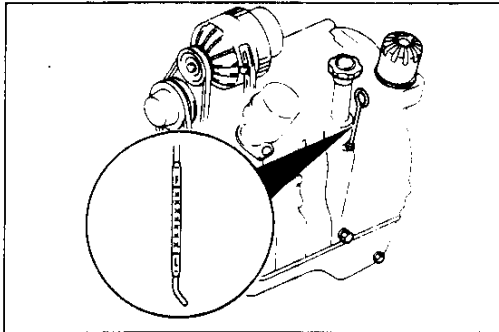

67U00X-006

REPLACEMENT OF ENGINE OIL

1. Warm up the engine if it is cold.
2. Remove the drain plug.
3. Remove the oil filler cap. This will allow the oil to drain more easily.
4. Fill engine oil to the "F" mark on the dipstick. Use oil with the proper SAE viscosity.

Oil capacity:

**Total: 4.9 L {5.2 US qt, 4.3 Imp-qt} except R1 model
5.4 L {5.7 US qt, 4.8 Imp-qt}..... R1 model**

Oil pan: 3.9 L {4.1 US qt, 3.4 Imp-qt}

Note

- After starting the engine, recheck the oil level and also check the drain plug washer for leaks.

Typical specification:

**API service "Fuel efficient"
SG grade (Mineral oil only)**

Recommended SAE viscosity numbers

Temperature	(°C)	-30	-20	-10	0	10	20	30	40	50	
	(°F)	-20	0	20	40	60	80	100	120		
Engine oil		5W-30									
							10W-30				

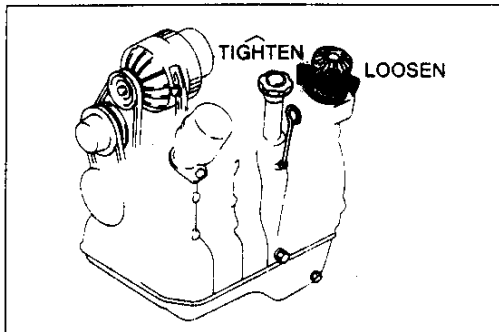

67U00X-007

REPLACEMENT OF ENGINE OIL FILTER

To install the oil filter, apply engine oil to the oil filter gasket, and then tighten the oil filter fully by hand.

Caution

- After installing the filter, start the engine and check that the joints are not leaking. Top up with oil if necessary.

INSPECTION OF DRIVE BELTS

1. Check the belt for cracks or any other damage.
2. If necessary, adjust the drive belt tension with thumb pressure of about 98N {10 kgf, 22 lbf}.

Alternator and air pump drive belt

1. Loosen the alternator mounting bolt and locknut.
2. Move the alternator to obtain proper belt tension.
3. Tighten the bolts and recheck the tension.

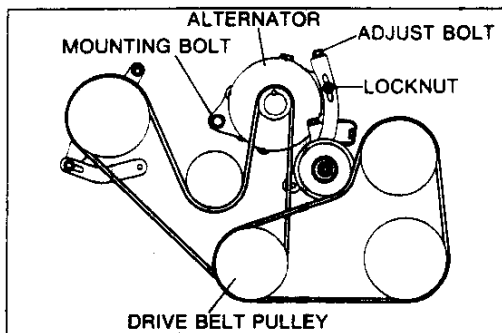

77U15X-012

Deflection	7.0-7.5 mm {0.28-0.29 in}
------------	---------------------------

A

SCHEDULED MAINTENANCE SERVICES

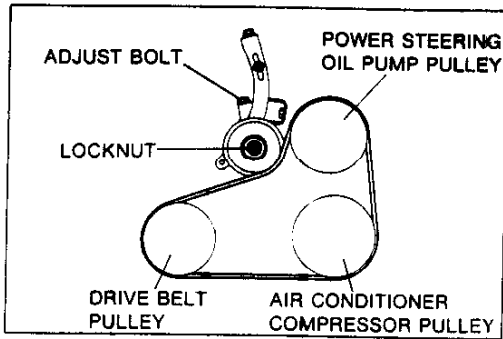

67U00X-009

Air conditioner drive belt (if equipped)

1. Loosen the lock nut on the idler pulley.
2. Turn the adjusting bolt until the correct tension is obtained.
3. Tighten the lock nut and recheck the tension.

Deflection	4.5-5.0 mm {0.18-0.20 in}
------------	---------------------------

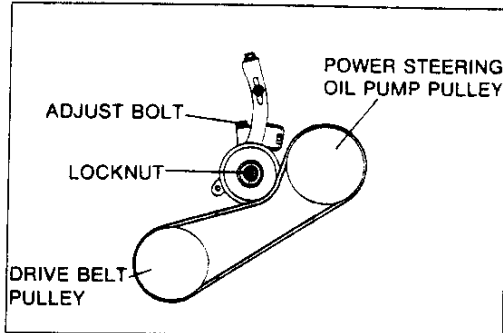

67U00X-010

Power steering oil pump drive belt

1. Loosen the lock nut on the idler pulley.
2. Turn the adjusting bolt until the correct tension is obtained.
3. Tighten the lock nut and recheck the tension.

Deflection	4.5-5.0 mm {0.18-0.20 in}
------------	---------------------------

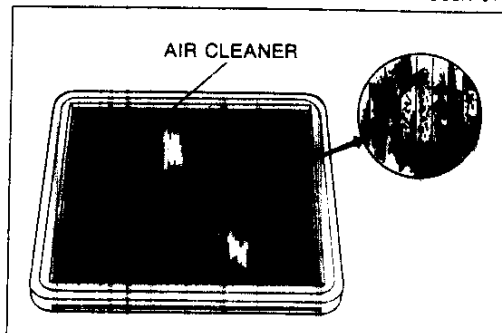

67U00X-011

REPLACEMENT OF AIR CLEANER ELEMENT

Use only a genuine Mazda air cleaner element or one of equivalent quality.

INSPECTION OF SPARK PLUGS

Check the following points. If a problem is found, replace the spark plug.

- Damaged insulation
- Worn electrodes
- Carbon deposits

If cleaning is necessary, use a plug cleaner or a wire brush. Clean the upper insulator, also.

- Damaged gasket
- Burnt

Plug gap: 1.0-1.1 mm {0.040-0.043 in}

Plug position	NGK	Discrimination color
Leading side	BUR7EQP*, (BUR7EQ) (BUR6EQP) (BUR6EQ)	-
Trailing side	BUR9EQP*, (BUR9EQ) (BUR8EQP) (BUR8EQ)	Blue

* Standard plug

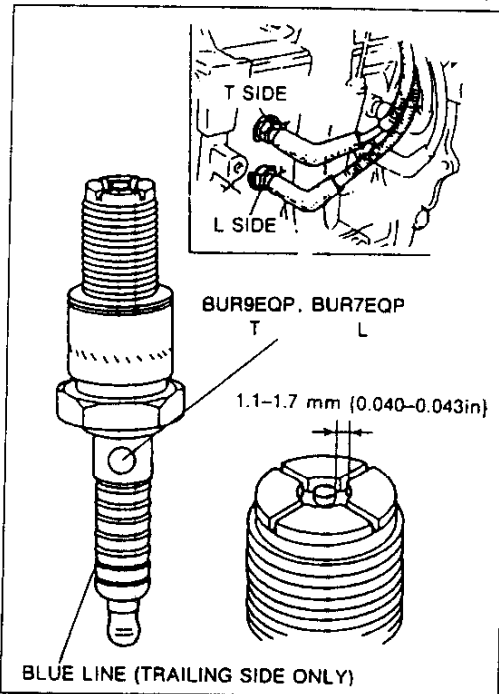

Caution

- To protect the platinum electrode:
 - (1) Do not use a wire brush to clean the electrode.
 - (2) Use a plug cleaner for a maximum of 20 seconds and air pressure below 589 kPa {6 kgf/cm², 85 psi}.
 - (3) Do not adjust the plug gap to protect a platinum electrode.

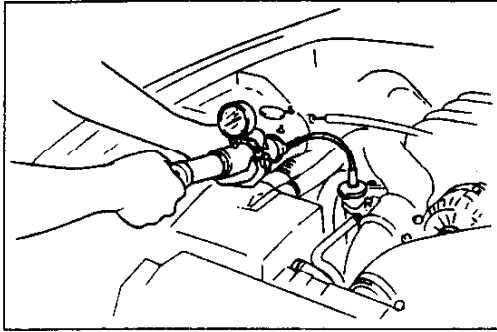

77U00X-005

INSPECTION OF COOLING SYSTEM

1. Check the cooling system hoses (including the heater hoses) for cracks or wear.
2. Check the cooling system for leaks by applying a pressure of 103 kPa {1.05 kgf/cm², 14.93 psi} with a radiator cap tester.

Note

- Do not pressurize the system to more than 103 kPa {1.05 kgf/cm², 14.93 psi}.

If necessary, replace the hoses.

Warning

- Be careful to avoid injury from escaping steam or hot water when removing the radiator cap.

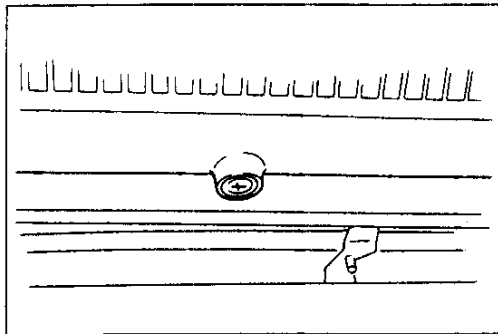

67U00X-014

REPLACEMENT OF ENGINE COOLANT

Drain the engine coolant by removing the radiator drain plug.

Warning

- Be careful to avoid injury when checking a hot engine.

Fill with new coolant according to the recommended mixture ratio as follows.

Protection	Mixture percentage (volume)	
	Anti-freeze solution	Water
Above -4°C {25°F}	20	80
Above -16°C {3°F}	35	65
Above -26°C {-15°F}	45	55
Above -40°C {-40°F}	55	45

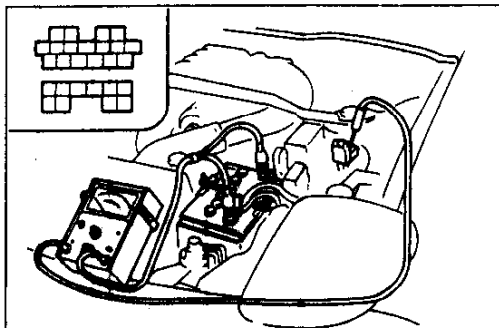

INSPECTION OF IDLE SPEED

Preparation

1. Warm up the engine to normal operating temperature.
2. Turn all electric loads OFF.
3. Connect the **SST** to the diagnosis connector.
4. Connect a tachometer to the diagnosis connector **IG**-terminal as shown.

A

SCHEDULED MAINTENANCE SERVICES

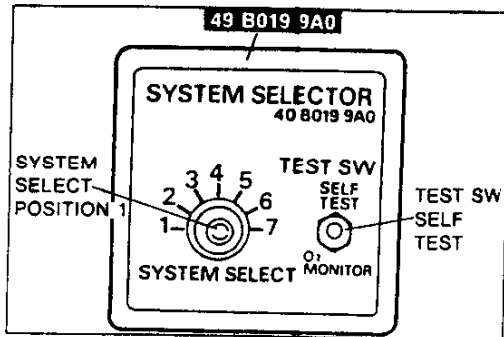

37U0FX-038

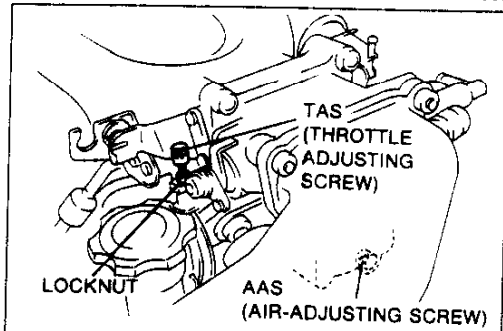

67U00X-032

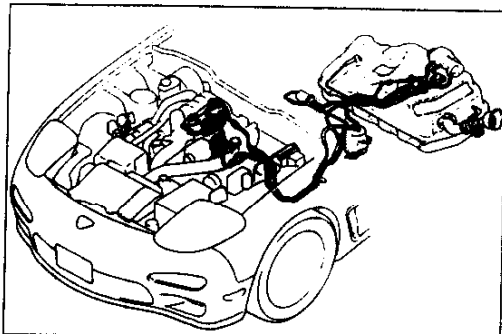
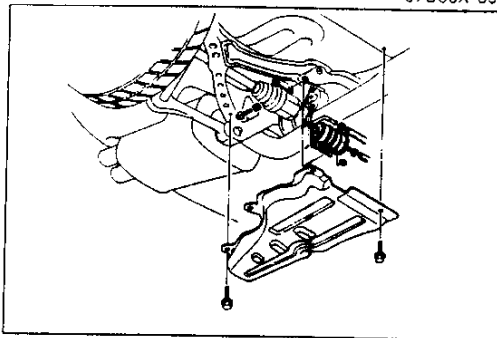

67U00X-016

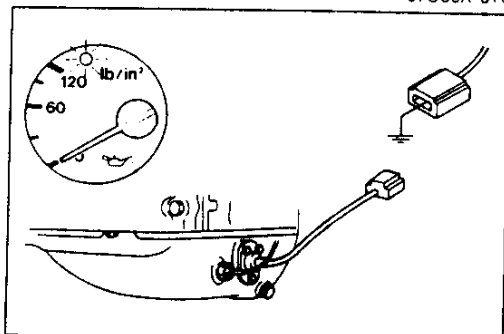

67U00X-017

Idle Speed

1. Perform "Preparation".
2. Verify that the idle speed is within specification.

Idle speed: 700–750 rpm

Caution

- Check the idle speed when the electric cooling fan does not operate.

3. If not within the specification, adjust the idle by turning the air-adjusting screw. (AAS)
4. If not within specification when air adjusting screw fully closed, loosen the locknut and turn the throttle adjusting screw to set the idle.
5. Tighten the locknut and put a paint mark on the nut and throttle body.
6. Disconnect the **SST**.

REPLACEMENT OF FUEL FILTER

Replace the fuel filter with a new one.

Note

- Be careful of the fuel flow direction on the filter.

Caution

- a) Cover the hoses with a rag since fuel will be splashed out when you disconnect the hoses.
- b) Keep sparks and open flames away from the fuel area.

INSPECTION OF FUEL LINES

1. Check the fuel line fittings, connections and components for leaks.
2. There should be no wetness or stained areas that might indicate leaks.
3. Replace any defective hoses or clips.

INSPECTION OF OIL LEVEL WARNING SYSTEM

1. When you turn the ignition switch ON, the oil level warning light comes ON.
2. Start the engine and the warning light should go OFF.
3. Disconnect the connector from the oil level sensor and ground the terminal at idle.
The oil level warning light comes ON and the buzzer sounds.
4. Remove the sensor.
5. Check that the oil holes of the oil chamber are not clogged.
If necessary, clean the oil holes with solvent.

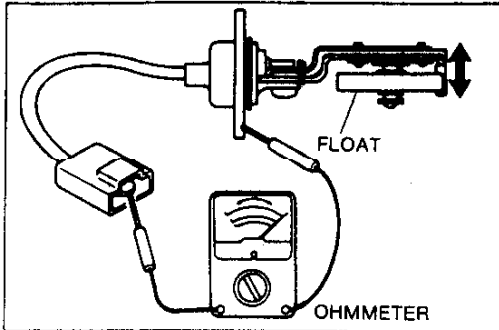

67U00X-000

6. Connect an ohmmeter to the level sensor and check the continuity by moving the float up and down. When the float is on the upper side, the ohmmeter should not show any continuity. When moved to the lower side, it should show a continuity of the circuit. If this is found not to be so, replace the oil level sensor.

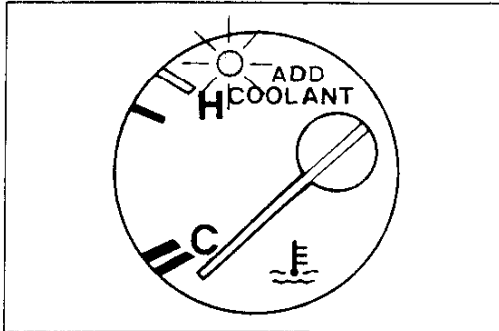

67U00X-018

INSPECTION OF ENGINE COOLANT LEVEL WARNING SYSTEM

1. Turn the ignition switch ON. The coolant level warning light comes ON.
2. Start the engine and the warning light should go OFF.
3. Disconnect the connector from the level sensor and make sure the warning light comes ON after 9–16 seconds and the buzzer sounds at idle.

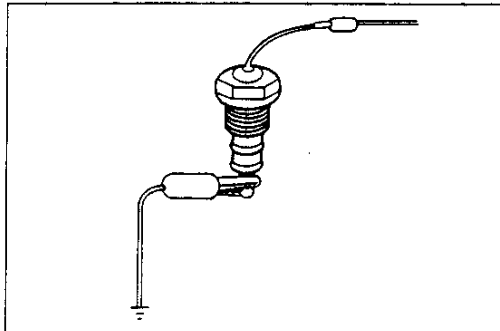

67U00X-031

4. Remove the radiator cap to relieve the pressure in the radiator.
5. Remove the sensor from the radiator and plug the hole to prevent coolant leakage.
6. Carefully check the sensor for cracks or damage.
7. Start the engine.
8. Ground the tip of the sensor. Check to see if the coolant level warning light goes OFF. If it does not, replace the sensor.

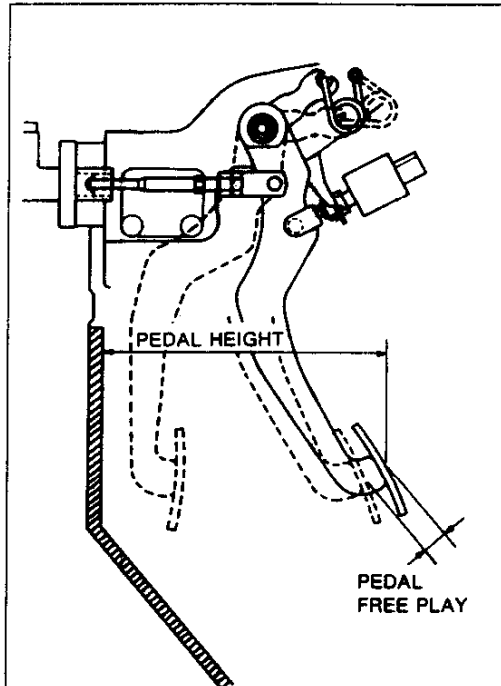

INSPECTION OF CLUTCH PEDAL

Clutch Pedal Height

Measure the distance from the upper surface of the pedal to the carpet.

Pedal height: 165.5–177.0 mm {6.516–6.968 in} (with carpet)

If necessary, adjust the pedal height.

Clutch Pedal Free Play

Depress the clutch pedal by hand until clutch resistance is felt.

Pedal free play: 0.6–3.2 mm {0.02–0.13 in}
Total pedal free play: 5.1–14 mm {0.20–0.55 in}

If necessary, adjust the pedal free play.

A

SCHEDULED MAINTENANCE SERVICES

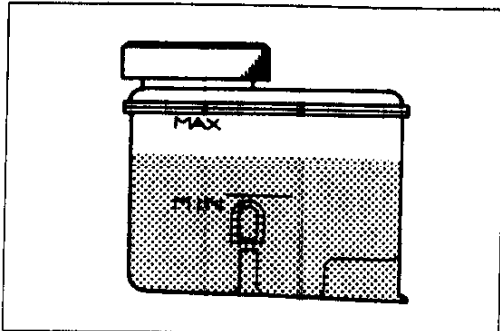

37U0HX-006

INSPECTION OF CLUTCH FLUID

Note

- A common reservoir is used for the clutch and brake system fluids.

1. Make sure that fluid level in the reservoir is between the MAX and MIN mark.
2. If the fluid level is extremely low, check the clutch and brake systems for leakage.

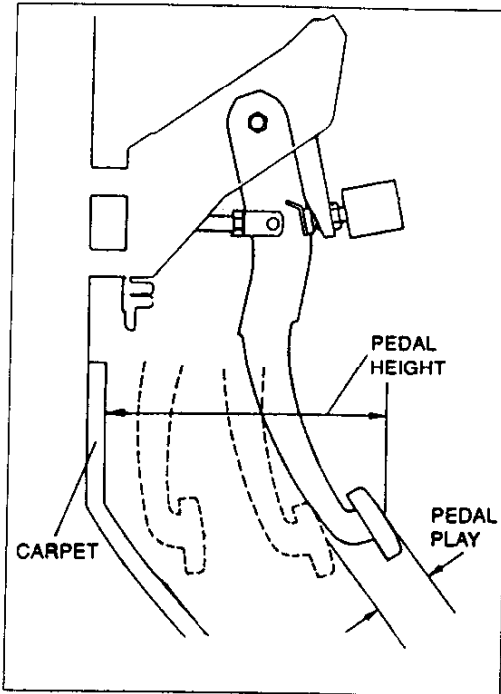

INSPECTION OF BRAKE PEDAL

Pedal Height Inspection

Check if the distance from the center of the upper surface of the pedal pad to the carpet is as specified.

Pedal height: 164.5–176.0 mm {6.48–6.92 in}
(with carpet)

Pedal Play Inspection

1. Depress the pedal a few times to eliminate the vacuum in the system.
2. Lightly depress the pedal by hand until resistance is felt and check the free play.

Free play: 3–8 mm {0.12–0.31 in}

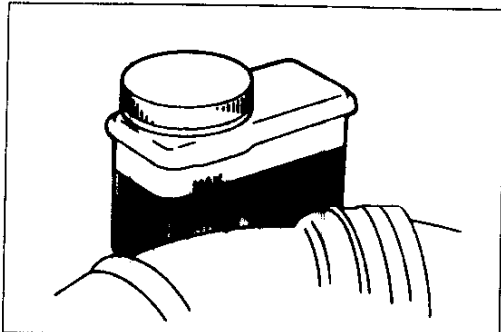

39G00X-030

INSPECTION OF BRAKE FLUID

Check that the brake fluid level is near the "MAX" level line on the see-through reservoir. If necessary, add brake fluid to bring the level to the "MAX" level line.

Fluid specification:
FMVSS 116 DOT-3

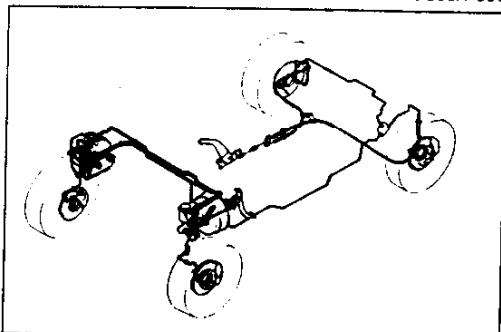

39G00X-028

INSPECTION OF BRAKE LINE, HOSES AND CONNECTIONS

Check the brake lines and hoses for proper attachment and connections. There should not be any leaks, cracks, chafing, abrasion, deterioration, etc. on lines and connections.

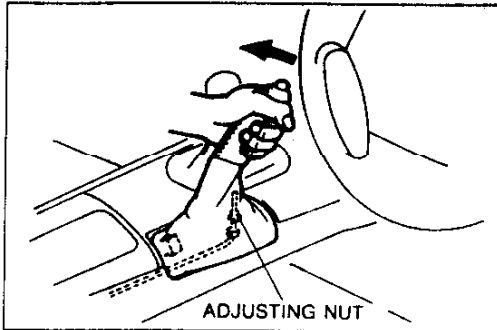

77U00X-009

INSPECTION OF PARKING BRAKE

1. Pull the brake lever with 200 N {20 kgf, 44 lbf} of force and measure the lever stroke.
2. If necessary, adjust the lever stroke by turning the adjusting nut.

Lever notices: 7-10

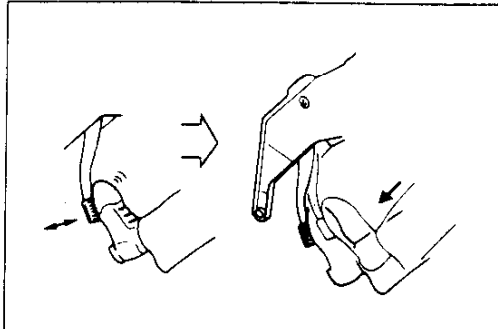

39G00X-032

INSPECTION OF POWER BRAKE UNIT AND HOSES

1. Check the vacuum hoses, connectors, and check the valve for cracks, chafing, deterioration, etc.
2. Check the power brake for proper operation. To check, depress the brake pedal several times to make sure the pedal play does not change. Then, while depressing the brake pedal, start the engine. At this time, the pedal should go down a little.

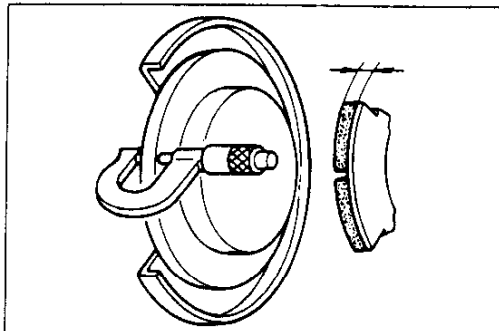

39G00X-033

INSPECTION OF DISC BRAKES

Check the following conditions of disc brake components.

1. Check caliper operation and inspect for leaks.
2. Check pads for wear.
3. Check condition and thickness of disc plate.

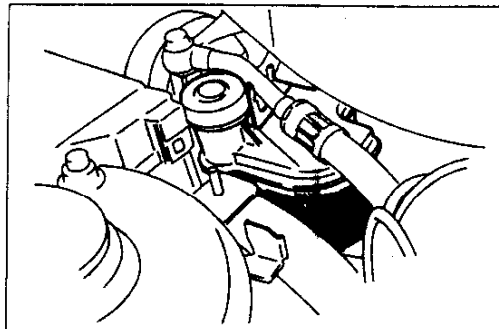

19G0AX-114

INSPECTION OF POWER STEERING FLUID LEVEL

Check the power steering fluid level. Add fluid to the specified level, if necessary.

Caution

- Use only the specified power steering fluid.

Fluid specification: ATF Dexron®II or M-III

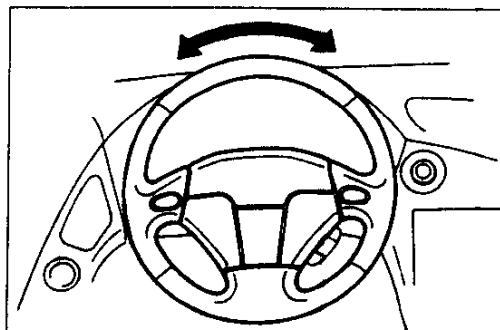

95A0AX-028

INSPECTION OF STEERING OPERATION AND LINKAGE

1. Check the steering wheel free play. (Refer to page N-6.)

Free play: 0-30 mm {0-1.18 in}

2. Check the steering for proper operation and for looseness of the steering housing.
3. Check the steering gear housing for fluid leakage or seepage.
4. Check for excessive play on the tie rod ends and rack guide.
5. Check for damage of the dust boots.
6. Check for looseness or grease leakage of the tie rod ends.

A

SCHEDULED MAINTENANCE SERVICES

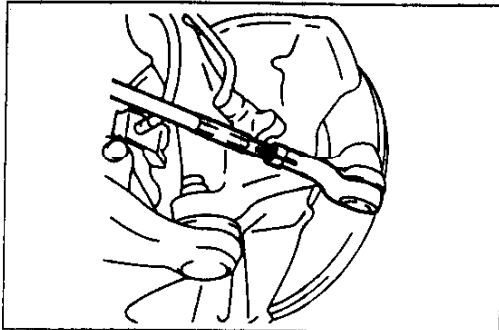

67U00X-023

INSPECTION OF STEERING LINKAGES, RACK GUIDE AND TIE ROD ENDS

Check the steering linkage for looseness and damage. Check that there is:

1. No excessive play on tie rod ends and rack guide.
2. No looseness or grease leakage on tie rod ends.

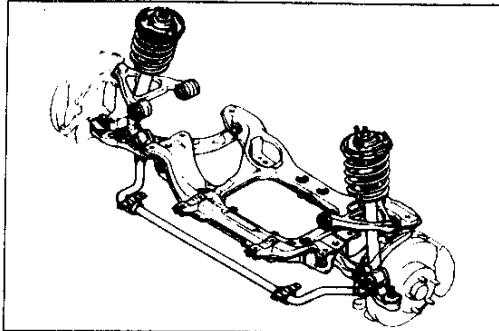

39G00X-038

INSPECTION OF SUSPENSION BALL JOINTS

Check the ball joints for damage, looseness and grease leakage.

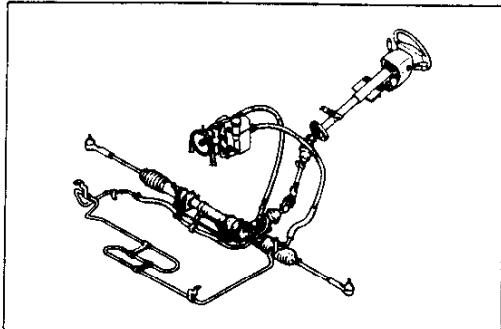

67U00X-024

INSPECTION OF RACK SEAL BOOTS

Check the boot for cracking or other damage. If a problem is found, replace the boot.

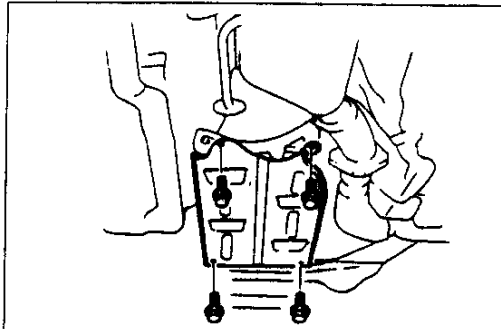

37U0JX-007

INSPECTION OF MANUAL TRANSMISSION OIL

Caution

- Park the vehicle on level ground.

1. Remove the transmission cover.
2. Remove the filler plug.
3. Verify that the oil is up to the bottom of the check plug hole.
4. If the oil level is low, add the specified oil through the filler plug port.
5. Install a new filler plug.

Tightening torque:

25-39 N·m {2.5-4.0 kgf·m, 19-28 ft·lbf}

6. Install the transmission cover.

Tightening torque:

7.9-10.7 N·m {80-110 kgf·cm, 70-95.4 in·lbf}

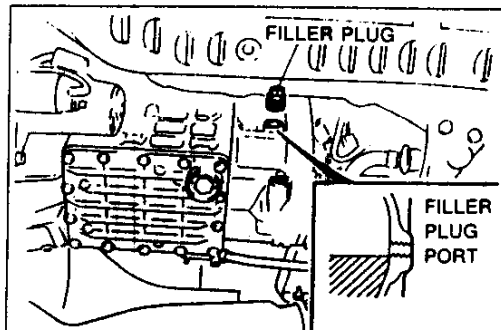

37U0JX-008

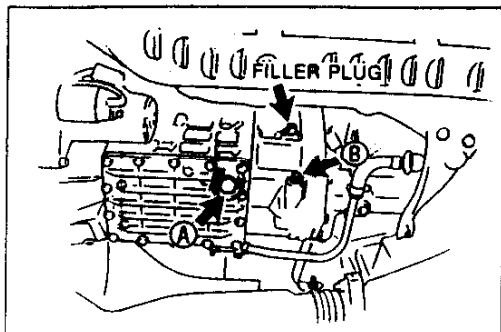

37U0JX-009

REPLACEMENT OF MANUAL TRANSMISSION OIL

1. Remove the transmission cover.
2. Remove plug A (with washer) and B, and drain the oil into a suitable container.
3. Wipe all plug clean.
4. Apply sealant to the B plug threads.
5. Install new plugs A (with new washer) and B.

Tightening torque:

A: 40–58 N·m {4.0–6.0 kgf·m, 29–43 ft·lbf}

B: 21–31 N·m {2.1–3.2 kgf·m, 16–23 ft·lbf}

6. Remove filler plug and add the specified oil through the filler plug port until the level rises to the bottom of the port.

Specified oil:

Grade: API service GL-4 or GL-5

All-season: SAE 75W-90

Above 10°C {50°F}: SAE 80W-90

Capacity: 2.5 L {2.6 US qts, 2.2 Imp qts}

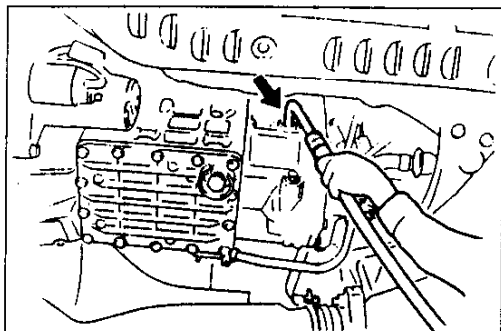

37U0JX-010

7. Install a new filler plug.

Tightening torque:

25–39 N·m {2.5–4.0 kgf·m, 19–28 ft·lbf}

8. Install the transmission cover.

Tightening torque:

7.9–10.7 N·m {80–110 kgf·cm, 70–95.4 in·lbf}

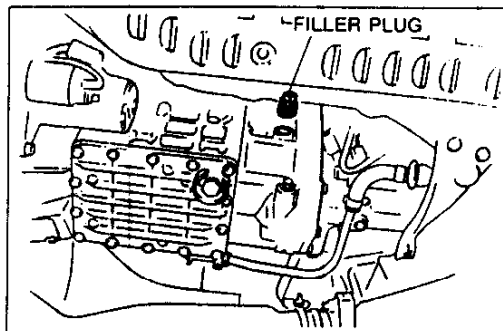

37U0JX-011

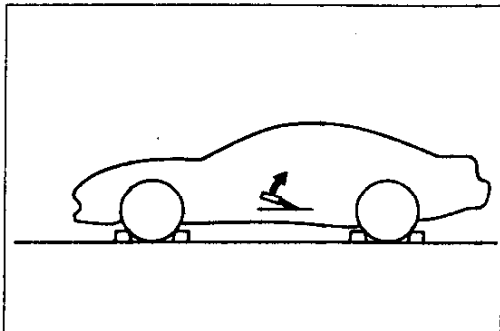

19G0KX-121

INSPECTION OF AUTOMATIC TRANSMISSION FLUID LEVEL

Caution

- Place the vehicle on a flat, level surface.

1. Apply the parking brake and securely position wheel chocks to prevent the vehicle from rolling.
2. Warm up the engine until the ATF temperature reaches **60–70°C {140–158°F}**.

3. While depressing the brake pedal, shift the selector lever to each range (P–L). Leave it a few seconds in each range.
4. Shift back to P range.

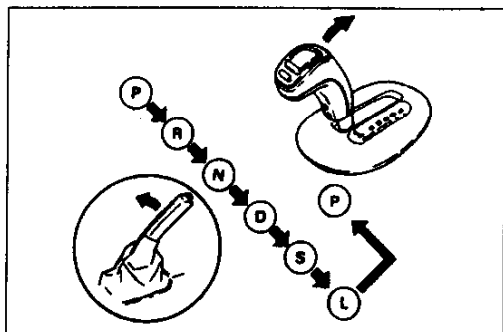

19G0KX-122

A

SCHEDULED MAINTENANCE SERVICES

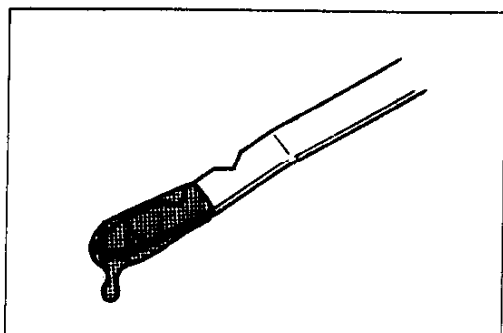

19G0KX-123

5. Ensure that the ATF level is between the notches of the ATF dipstick. Add ATF to the specified level, if necessary.

ATF Type: Dexron®II or M-III

Capacity: 8.6 L {9.1 US qt, 7.6 Imp qt}

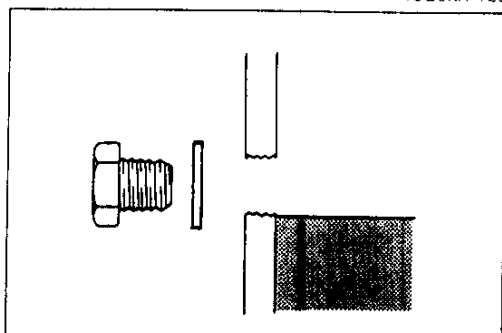

37U0MX-050

INSPECTION OF DIFFERENTIAL OIL

Caution

- Position the vehicle level.

1. Remove the filler plug.
2. Verify that the oil is at the bottom of the filler plug hole. If it is low, add the specified oil.
3. Install a new washer and the filler plug.

Tightening torque:

39–53 N·m {4.0–5.5 kgf·m, 29–39 ft·lbf}

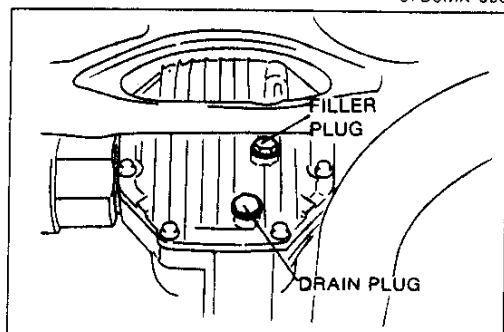

37U0MX-051

REPLACEMENT OF DIFFERENTIAL OIL

1. Remove the filler and drain plugs.
2. Drain the differential oil into a suitable container.
3. Wipe the plugs clean.
4. Install a new washer and the drain plug.

Tightening torque:

39–53 N·m {4.0–5.5 kgf·m, 29–39 ft·lbf}

5. Add the specified oil from the filler plug hole until it reaches the bottom of the hole.

Specified oil

Type

Above –18°C {0°F}: API GL-4 or 5, SAE 90

Below –18°C {0°F}: API GL-4 or 5, SAE 80

Capacity: 1.30 L {1.38 US qt, 1.14 Imp qt}

6. Install a new washer and the filler plug.

Tightening torque:

39–53 N·m {4.0–5.5 kgf·m, 29–39 ft·lbf}

29U0MX-060

On vehicles equipped with limited-slip differential, API GL-5, SAE 90 special lubricant is required for limited-slip differentials.

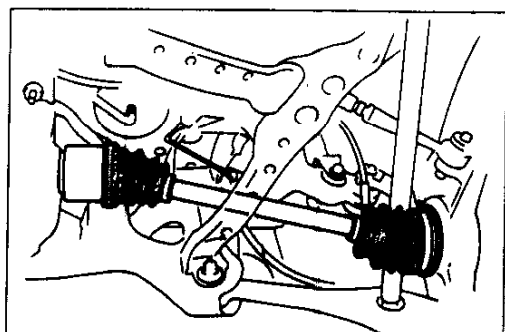

19G0AX-123

INSPECTION OF DRIVE SHAFT DUST BOOTS

Check the dust boot on the drive shaft for cracks, damage, grease leakage, and a loose boot band.

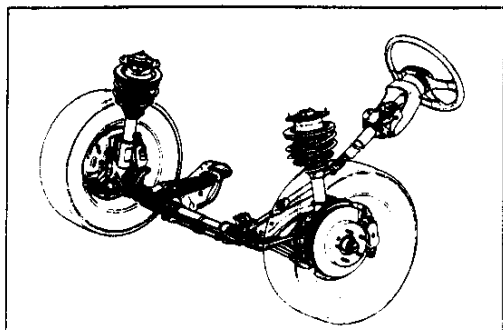

67U00X-027

TIGHTENING BOLTS AND NUTS ON CHASSIS AND BODY

1. Tighten all seat mounting bolts.
2. Retighten all loose nuts and bolts of front and rear suspensions to the specified torque. (Refer to Section 30)

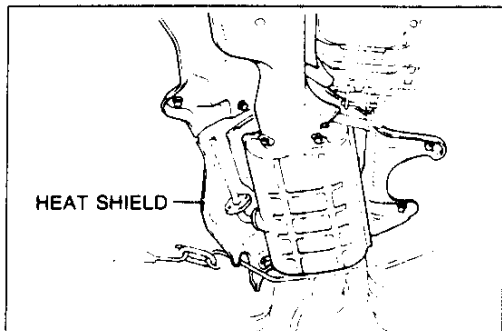

47U00X-063

INSPECTION OF EXHAUST SYSTEM HEAT SHIELDS

1. Check the clearance between insulator and body, and also between the insulator and the exhaust system.
2. Visually inspect the pipes, hangers and connections for severe corrosion, leaks or damage.

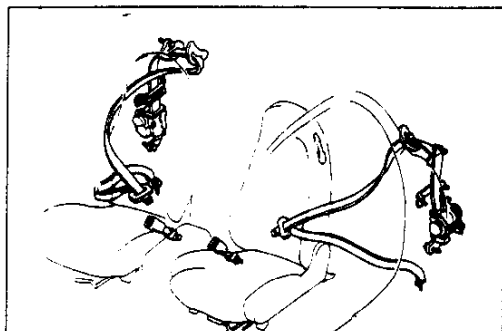

67U00X-028

INSPECTION OF SEAT BELTS, BUCKLES, RETRACTORS AND ANCHORS

1. Pull each seat belt to be sure it moves smoothly.
2. Check for scratches, tears, or wear of the webbing, and doe bent metal fittings.

Caution

● **Do not disassemble the buckle or ELR assembly.**

3. Check operation of retractors.
4. Check tightness of belt anchor bolts.

